

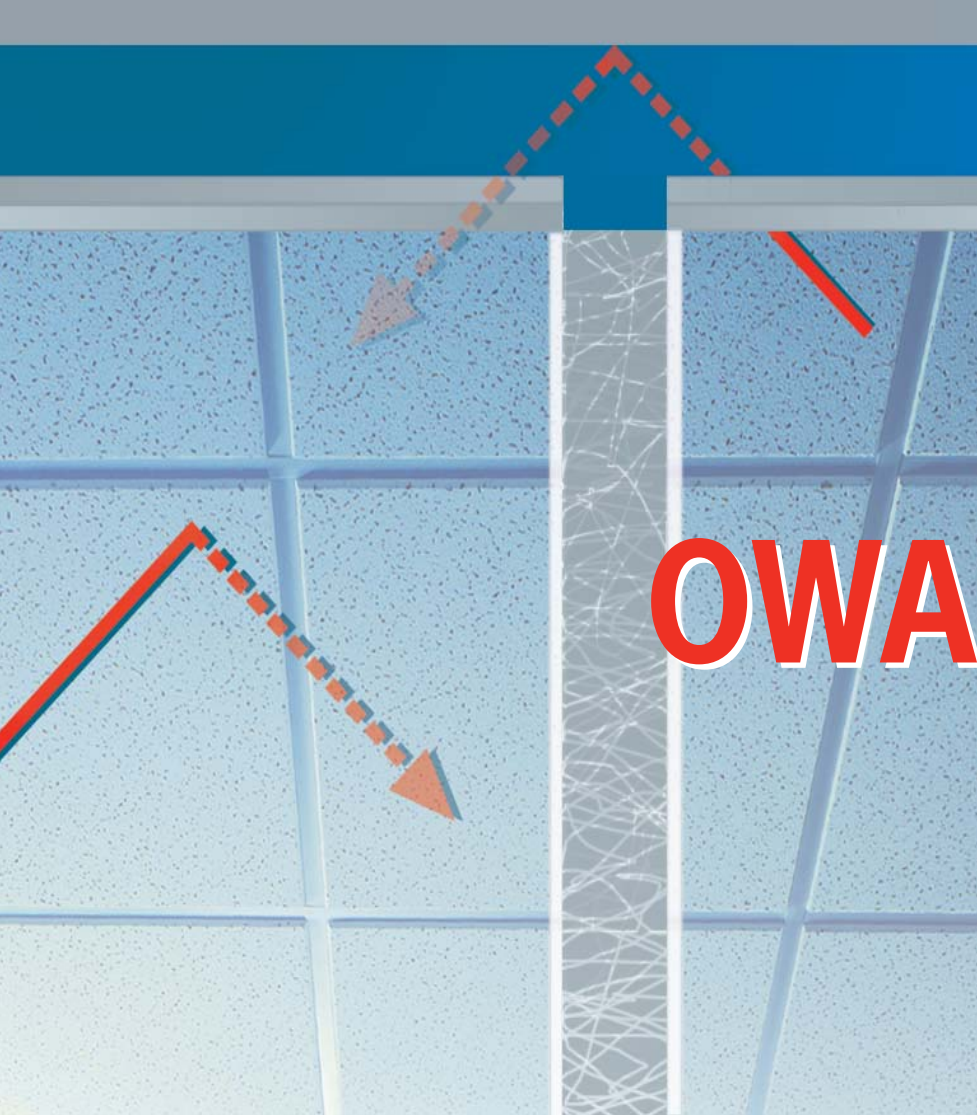

**OWAcoustic[®]
premium**



OWAcoustic[®] janus

The tile
that gives both:
Sound absorption
and Sound reduction.



OWA

Sound under control.

When high levels of sound insulation are essential.

This can be applicable to situations where a high level of sound reduction is required above and below a room area, particularly in continuous roof space constructions where there is a requirement to prevent excessive noise levels from penetrating to the outside e.g. in sports halls, factories, disco clubs etc.

Where high sound protection is required when using movable partitions.

Partition walls that only extend to the underside of a suspended ceiling can create an acoustic problem in the continuous ceiling cavity above the room areas. This situation is applicable to most modern offices and administration buildings. In such situations, an OWAcoustic®-janus ceiling can provide optimal solutions to the problem:

by effectively protecting the outside - and calming the inside.



The construction principle:

Two OWAcoustic®-tiles are bonded together using a special adhesive. The reverse side of the janus tile is always deep fissured enabling it to act as a damper within the ceiling cavity. The exposed face of the tile can be one of a number of either plain or patterned surfaces.

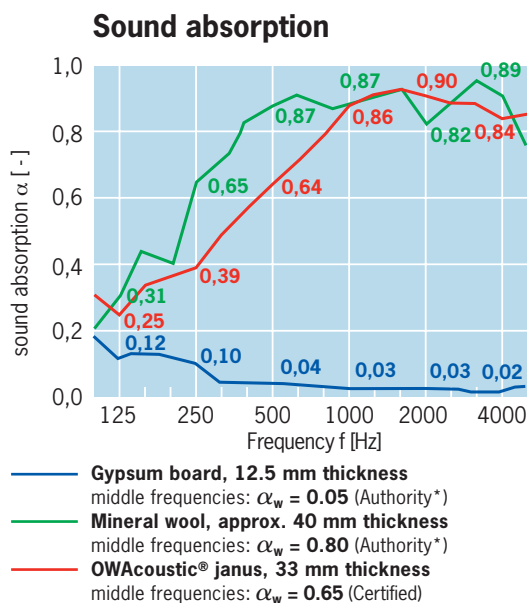

Sound reduction function:

The noise from the source area penetrating the ceiling cavity is reduced by the double thickness of the janus tile. It is then dampened further by the fissured sound absorbing reverse face of the tile. The residual noise is again reduced as it passes once more through the double thickness of the tile and into the receiving area – at a considerably reduced level.

Sound absorption function:

Air, and with it noise, penetrates the perforated surface of the ceiling tile. As a result of the friction created between air and the mineral wool, there is a loss of acoustic energy across the tile surface, resulting in a reduction of the noise levels generated within the area. For acoustical reasons it may sometimes be necessary to have a reflective surface - OWAcoustic®-janus tiles can be supplied with both plain and perforated surfaces.

Access to the ceiling cavity:

Suspended ceilings without sufficient sound insulation require overlays of mineral wool or specialist sound blocking panels. This can lead to problems when the ceiling needs to be accessed to reach services within the cavity. A full-flat wool overlay or even panels loose laid over the ceiling tiles can be displaced when opening the ceiling and it is likely that they will not be fully replaced when the ceiling is closed. Inevitably this will eventually result in a decrease in the sound insulation value of the ceiling. OWAcoustic®-janus are special high sound attenuating ceiling tiles which can be moved as a total unit which means security that the sound insulation performance remains intact.

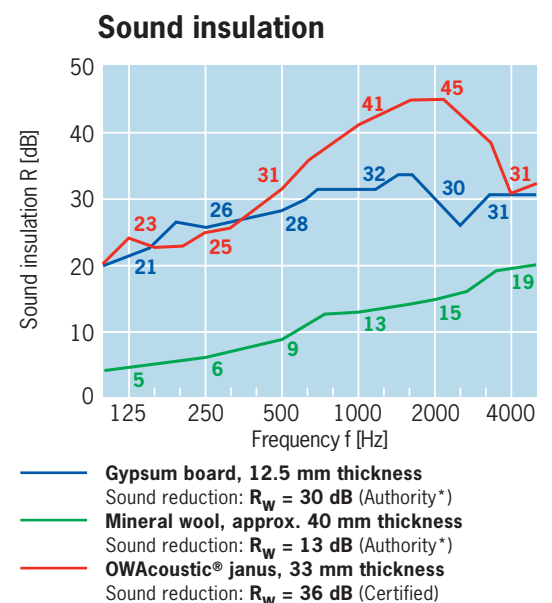

Note: The values represent a window testing and are pure material values without consideration of a metal suspension system.

* Fasold, Sonntag, Winkler, „Building and Room Acoustics“, VEB publication for Building, Berlin 1987

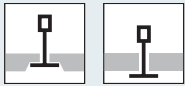

S 3, S 3a

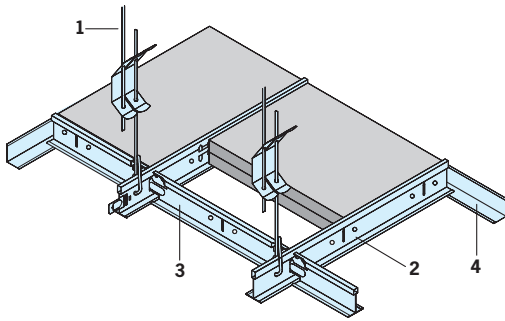

- 1 Adjustable hanger
- 2 Main runner
- 3 Cross tee
- 4 Perimeter trim

Dimensions:

600 x 600 mm
625 x 625 mm

600 x 1200 mm
625 x 1250 mm

Widths: 300, 312.5 mm
Lengths: 1250, 1500, 1800 mm

Other sizes available on request.

Thickness: 33 mm

Edges:



S 3 Section through main runner

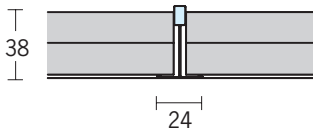

S 3a Section through main runner

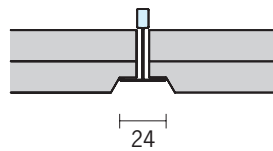

Special for janus:
Main runner spacing: 625 (600) mm
Hanger spacing: max. 1250 mm

Room to room reduction

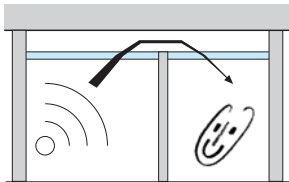

OWAcoustic® janus with System S 3

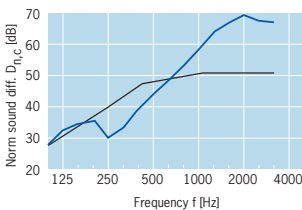

Design: Harmony
Sound reduction:
D_{n,c,w} = 47 dB (Certified)

OWAcoustic® janus with System S 18p

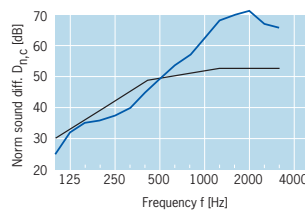

Design: Harmony
Sound reduction:
D_{n,c,w} = 49 dB (Certified)



S 18p

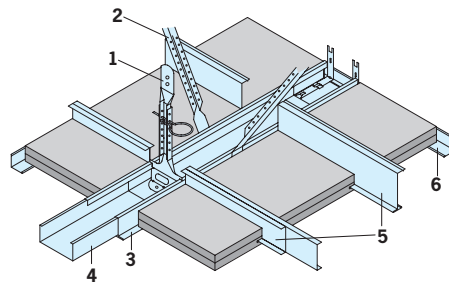

- 1 Rigid adjustable hanger
- 2 Angle bracings
- 3 Bandraster
- 4 Connector
- 5 Concealed Z-sections
- 6 Perimeter trim

Dimensions:

600 x 1200 mm
625 x 1250 mm

Widths: 300, 312.5 mm
Lengths: 1250, 1500, 1800 and 2000 mm

Thickness: 30 mm

Edges:



Short edge Long edge

Section through Bandraster

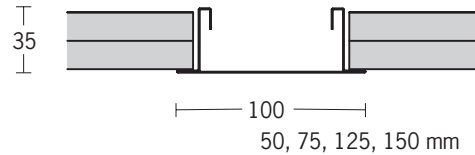

Special for janus:
Concealed sections for long edges of panels:
No. 69 Z-section – up to max. 1500 mm
No. 19 Z-section – up to max. 2000 mm
No. 36 C-section – up to max. 2000 mm



S 18d

Janus as System **S 18d**
with exposed cross tees

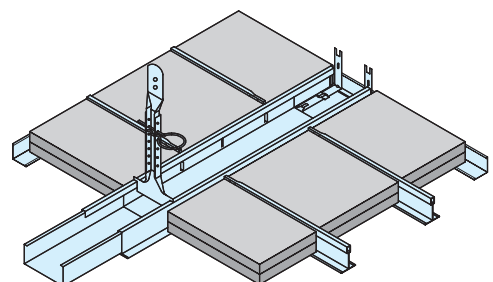

OWAcoustic®
premium

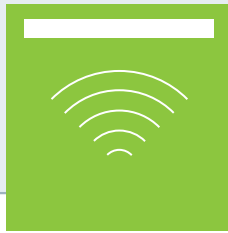

janus

Surface patterns

Summary Overview:

OWAcoustic®-janus tiles can provide good room acoustics as well as simultaneous high room to room sound reduction. It is simple to install janus tiles quickly and economically by using suspension systems from the OWAconstruct® programme:

- Exposed grid systems S 3 and S 3a
- Bandraaster systems S 18p and S 18d

OWAcoustic®-janus tiles guarantee easy access for repair and renovation work without compromising the acoustical protection qualities of the ceiling.

Light fittings

OWAconstruct® light fittings have little effect on the sound insulation. Comparison measurements have been made with and without light fittings.

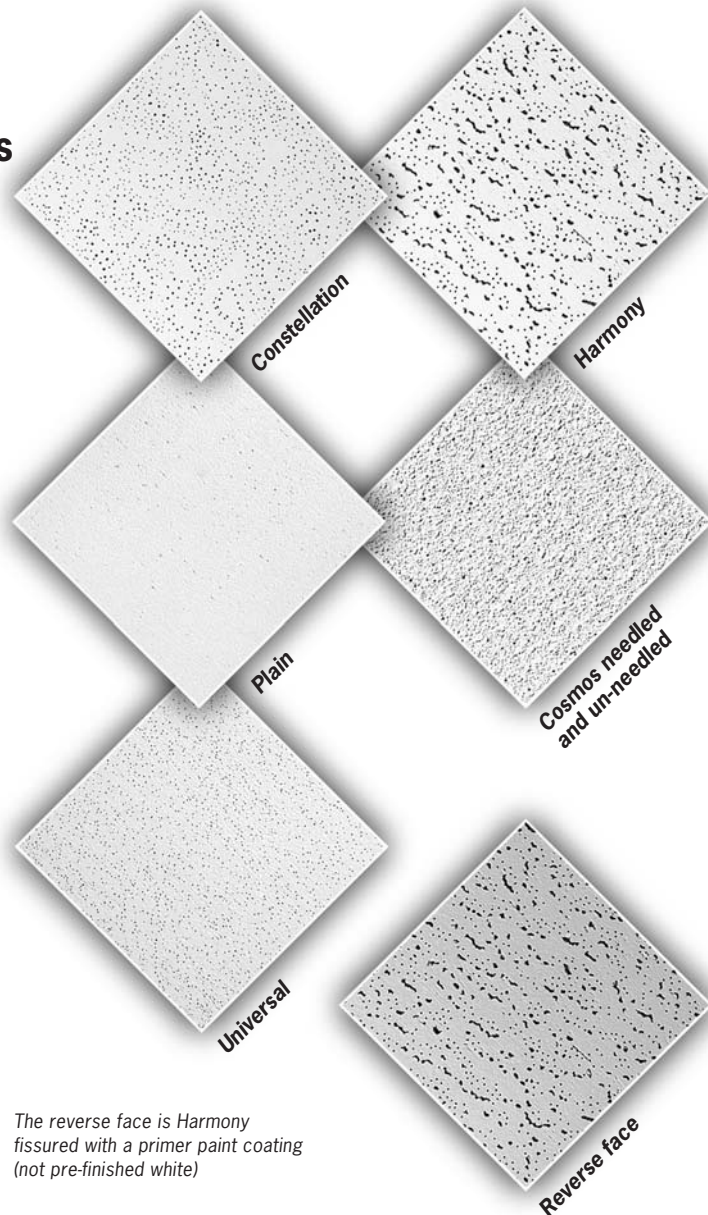

The reverse face is Harmony fissured with a primer paint coating (not pre-finished white)

All system relevant data and statements correspond to the current technology. They assume the exclusive application of OWA products and system components, the interdependent behaviour of which is confirmed by internal and external testing. When they are used in combination with non OWA products and system components any warranties or guarantees are invalidated and liability will not be accepted. OWA reserves the right to make any technical alterations to improve either product or system development. **All goods are supplied in accordance with our general sale and delivery terms.**

OWA

Odenwald
Faserplattenwerk GmbH
Dr.-F.-A.-Freundt-Straße 3
63916 Amorbach
Tel.: +49 9373 2 01-0
Fax: +49 9373 2 01-1 30
www.owa.de · E-mail: info@owa.de